

6,3 (✓)

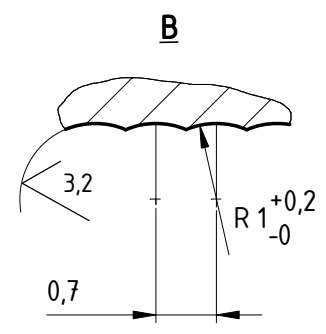
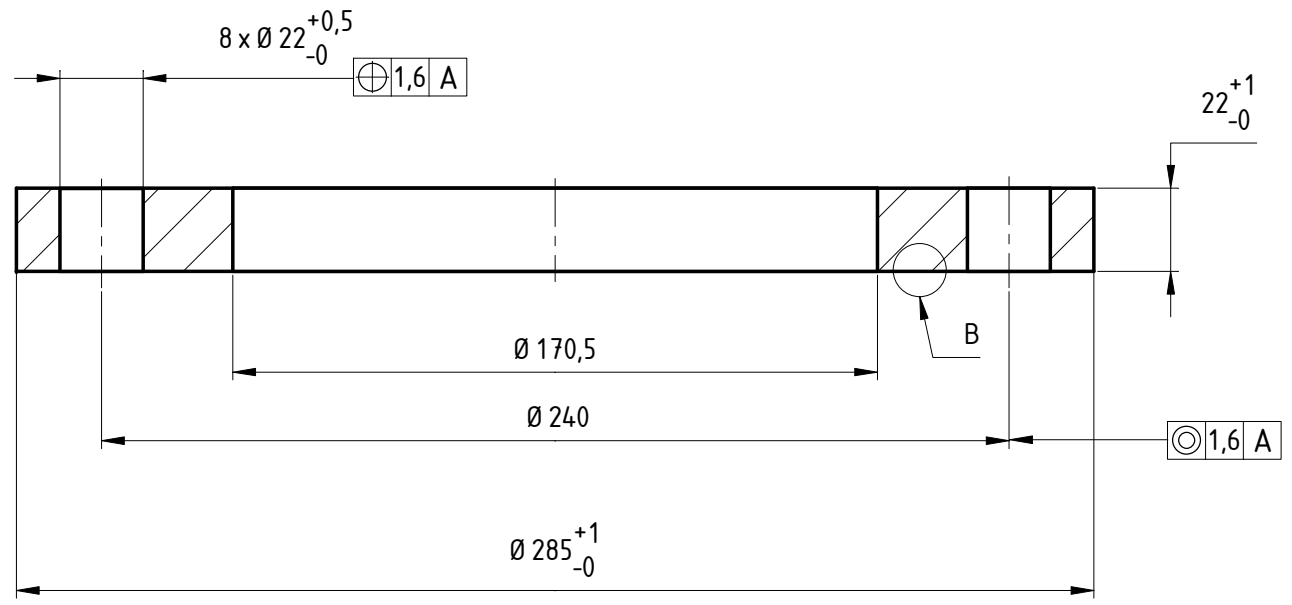

	Datum	Name	Maßstab: 1:2	Gewicht: 6,75 kg
bearb.			Werkstoff: 1.4541	
gepr.				
Norm				
(Firma) Euroflansch GmbH			Benennung: DN150 DIN2576 PN10 Form B	